

REV	CHANGE	DATE

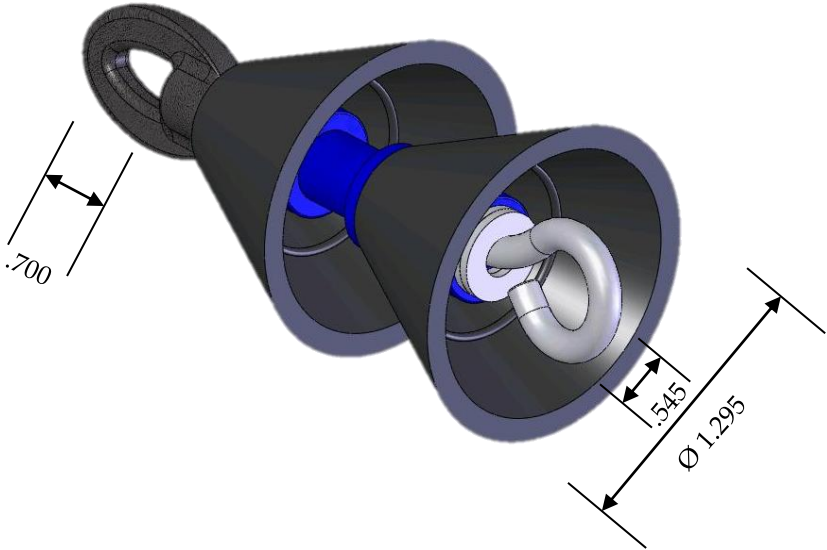

			
BY: F. GUERRERO	DATE: JUNE 02 2014	DESCR: 1 1/2" CAL MISSLE	SCALE: NONE AN:INCHES
MATERIAL: <ul style="list-style-type: none"> • POLYURETHANE CONES • PVC SPACERS. • CAUT STEEL EYE NUT • ZINC PLATED HARDWARE 		NO. 2110-015	REV. A