

REV	CHANGE	DATE

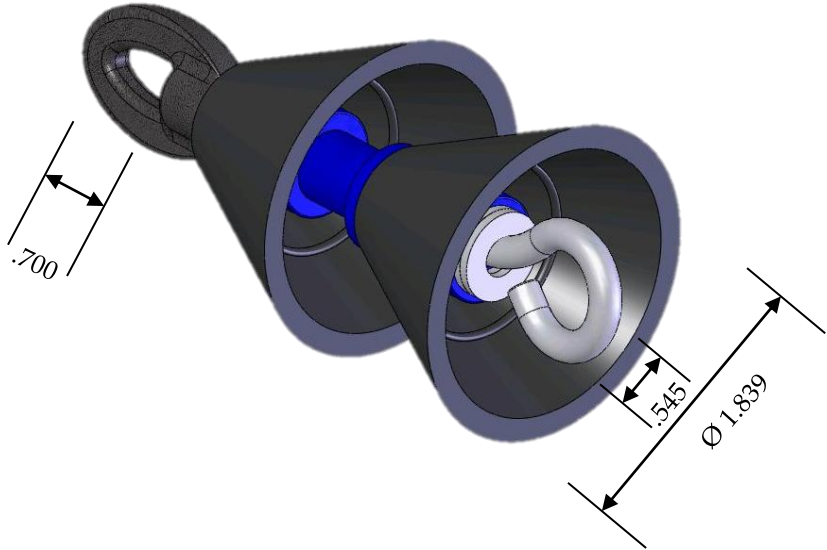

			
BY: F. GUERRERO	DATE: JUNE 02 2014	DESCR: 2" CAL MISSILE	SCALE: NONE AN:INCHES
MATERIAL: <ul style="list-style-type: none"> <li>• POLYURETHANE CONES</li> <li>• PVC SPACERS.</li> <li>• CAUT STEEL EYE NUT</li> <li>• ZINC PLATED HARDWARE</li> </ul>		NO. 2110-020	REV. A