

REV	CHANGE	DATE

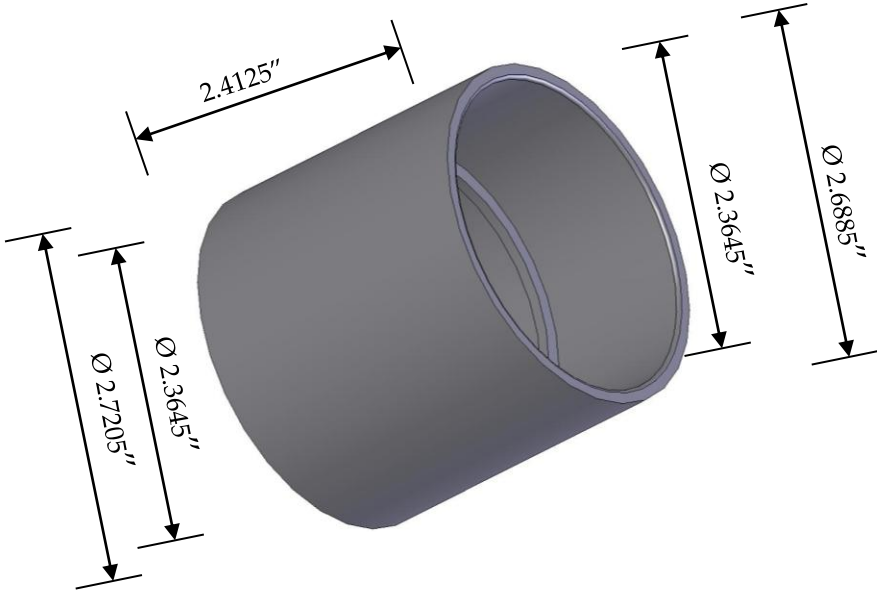

			
BY: F. GUERRERO	DATE: JUNE 02 2014	DESCR: 2" PVC COUPLING	SCALE: NONE AN: INCHES
MATERIAL: GRAY PVC	NO. 3250-020		REV. A